

DESIGN RENZO SERAFINI

Canna da pesca

PARETE/SOFFITTO WALL/CEILING

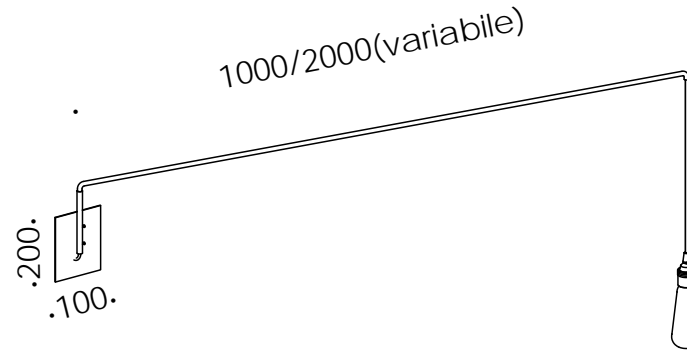

LAMPADA / ATTACCO
LAMP/ LAMP HOLDER

ATTACCO E27 230V

DESCRIZIONE DESCRIPTION

corpo in ferro con curve smerigliate,
cavo di alimentazione calzato in uscita,
disponibile in 3 misure 1000, 1500, 2000
variabili

black iron with sanded welds, wall plate
with power in wall plate, available in 3
variable measures 1000, 1500, 2000

COD.	70.019.3	cavo nero
	70.019.6	cavo marrone
	70.019.1	cavo bianco
MISURE	0 -1000	
FINITURA	ferro nero, corten, verniciatura bianca / black iron, corten, white painting	
MATERIALE	ferro / iron	
COD.	70.020.3	cavo nero
	70.020.6	cavo marrone
	70.020.1	cavo bianco
MISURE	1100 - 1500	
FINITURA	ferro nero, corten, verniciatura bianca / black iron, corten, white painting	
MATERIALE	ferro / iron	
COD.	70.030.3	cavo nero
	70.030.6	cavo marrone
	70.030.1	cavo bianco
MISURE	1600 - 2000	
FINITURA	ferro nero, corten, verniciatura bianca / black iron, corten, white painting	
MATERIALE	ferro / iron	

***lampadina non inclusa**
*bulb not included

Canna da pesca

ISTRUZIONI DI MONTAGGIO ASSEMBLY INSTRUCTION

PARETE/SOFFITTO WALL/CEILING

[disattivare l'alimentazione di rete prima di iniziare l'installazione]
[turn off the mains power before starting the installation]

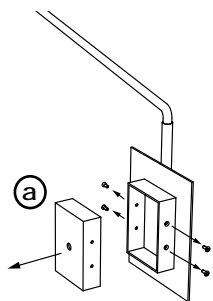

- 1 **smontare base 'a' e fissarla al muro**
get off base 'a' and fix it on the wall

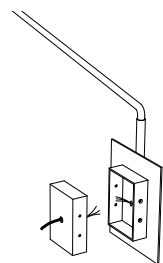

- 2 **eseguire il cablaggio con alimentazione 230V e collegare cavo giallo/verde di messa a terra**
do the wiring with 230V voltage and connect the yellow/green ground wire

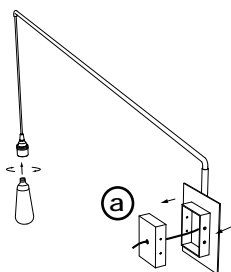

- 3 **fissare la struttura a base 'a' e avvitare la lampadina**
fix the structure to base 'a' and screw the bulb

DESIGN RENZO SERAFINI

Canna da pesca doppia

PARETE/SOFFITTO WALL/CEILING

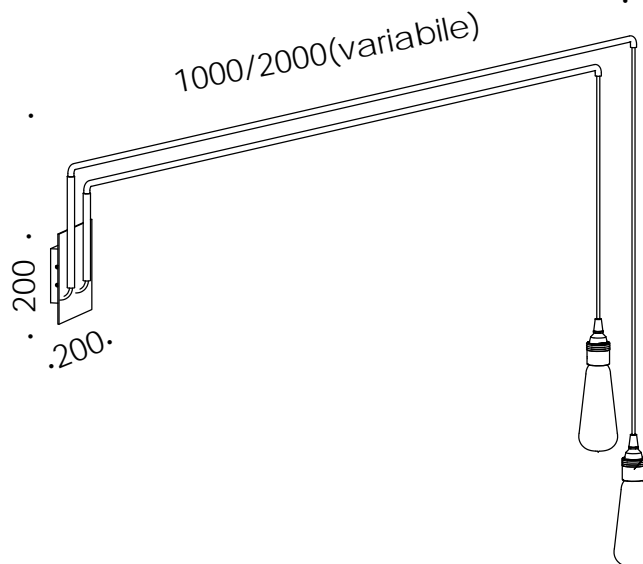

LAMPADA / ATTACCO
LAMP/ LAMP HOLDER

ATTACCO E27 230V

*lampadina non inclusa
*bulb not included

DESCRIZIONE DESCRIPTION

corpo in ferro con curve smerigliate,
cavo di alimentazione calzato in uscita,
disponibile in 3 misure 1000, 1500, 2000
variabili

black iron with sanded welds, wall plate
with power in wall plate, available in 3
variable measures 1000, 1500, 2000

COD. ART.CANNA.DOPPIA

FINITURA ferro nero, corten, verniciatura bianca
/ black iron, corten, white painting

MATERIALE ferro / iron

Canna da pesca

ISTRUZIONI DI MONTAGGIO ASSEMBLY INSTRUCTION

PARETE/SOFFITTO WALL/CEILING

[disattivare l'alimentazione di rete prima di iniziare l'installazione]
[turn off the mains power before starting the installation]

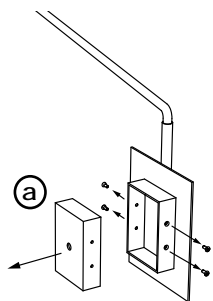

- 1 **smontare base 'a' e fissarla al muro**
get off base 'a' and fix it on the wall

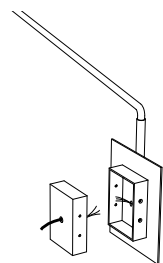

- 2 **eseguire il cablaggio con alimentazione 230V e collegare cavo giallo/verde di messa a terra**
do the wiring with 230V voltage and connect the yellow/green ground wire

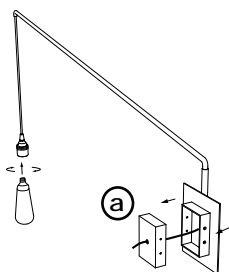

- 3 **fissare la struttura a base 'a' e avvitare la lampadina**
fix the structure to base 'a' and screw the bulb

DESIGN RENZO SERAFINI

Canna da pesca tripla

PARETE/SOFFITTO WALL/CEILING



IP20



DESCRIZIONE DESCRIPTION

corpo in ferro con curve smerigliate,
cavo di alimentazione calzato in uscita,
disponibile in 3 misure 1000, 1500, 2000
variabili

black iron with sanded welds, wall plate
with power in wall plate, available in 3
variable measures 1000, 1500, 2000

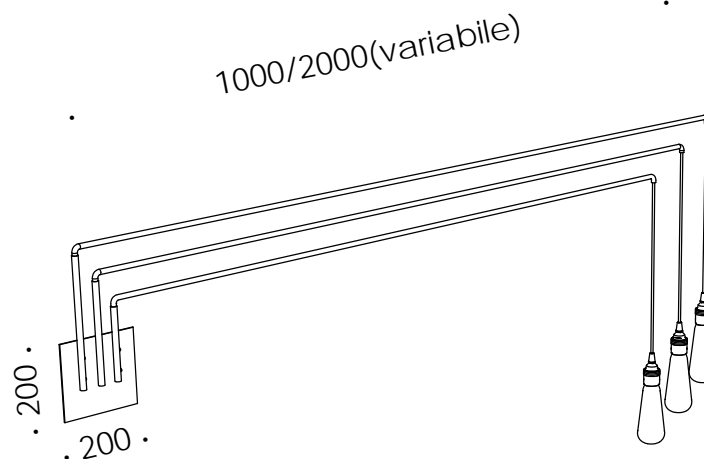

LAMPADA / ATTACCO
LAMP/ LAMP HOLDER

 ATTACCO E27 230V

*lampadina non inclusa
*bulb not included

COD. ART.CANNA.TRIPLA

FINITURA ferro nero, corten, verniciatura bianca
/ black iron, corten, white painting

MATERIALE ferro / iron

Canna da pesca

ISTRUZIONI DI MONTAGGIO ASSEMBLY INSTRUCTION

PARETE/SOFFITTO WALL/CEILING

[disattivare l'alimentazione di rete prima di iniziare l'installazione]
[turn off the mains power before starting the installation]

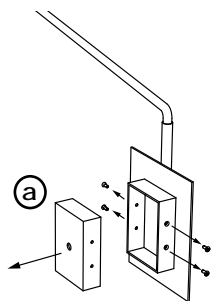

- 1 **smontare base 'a' e fissarla al muro**
get off base 'a' and fix it on the wall

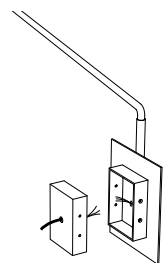

- 2 **eseguire il cablaggio con alimentazione 230V e collegare cavo giallo/verde di messa a terra**
do the wiring with 230V voltage and connect the yellow/green ground wire

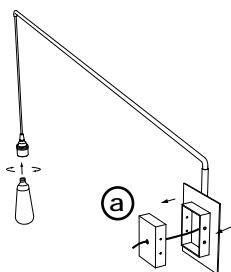

- 3 **fissare la struttura a base 'a' e avvitare la lampadina**
fix the structure to base 'a' and screw the bulb